

ateliê vivo

instruções gerais

A Biblioteca de Modelagem do Ateliê Vivo existe desde 2015 presencialmente, como um ambiente de estudo e prática têxtil. O objetivo é que as pessoas possam retomar o conhecimento e a autonomia da construção de uma roupa e demais técnicas manuais.

Procurando expandir o acesso ao acervo das Modelagens, começamos em 2021 o processo de digitalização dos moldes para disponibilizá-los em nosso site gratuitamente.

O formato para impressão é em tamanho A4 em folha sulfite comum, que pode ser feito em uma impressora caseira ou em gráficas rápidas. A montagem da modelagem funciona como um quebra cabeça.

Para iniciar imprima apenas esta página com a impressora configurada para não redimensionar o arquivo. Utilize a régua abaixo como um teste, confira se as medidas são iguais de uma régua comum.

Após ter confirmado a escala da régua imprima este arquivo completo com as mesmas configurações para iniciar a montagem.

Na segunda página deste arquivo têm o desenho técnico da roupa que você escolheu.

A terceira página deste arquivo, é um guia onde têm uma imagem reduzida de como todas as páginas unidas deverão ficar.

E agora vamos montar a modelagem:

Todas as folhas possuem marcas de junção nas laterais, uma elas com fita crepe, sem sobrepor.

Com as páginas todas unidas, recorte o tamanho desejado e pronto, agora você risca a modelagem no tecido, para cortar e costurar.

Como boa parte de nosso acervo consiste de doações de diferentes estilistas, não temos uma grade de tamanho padronizada, por isso utilize os tamanhos apenas como uma referência, aconselhamos tirar suas medidas antes e conferir o molde, na página da Biblioteca de Modelagem online têm um passo a passo de como tirar medidas para você acompanhar.

Quando terminar compartilhe conosco o resultado nas nossas redes.

Boa costura

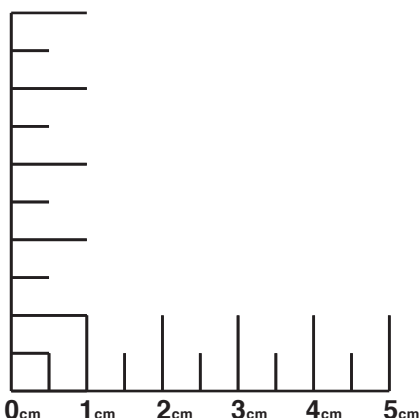

AV ateliê vivo

Designer : Ateliê Vivo

Modelo : Vestido Evasê

Tamanho : P - G - GG

Grau de dificuldade : fácil médio difícil

Tecido : plano malha

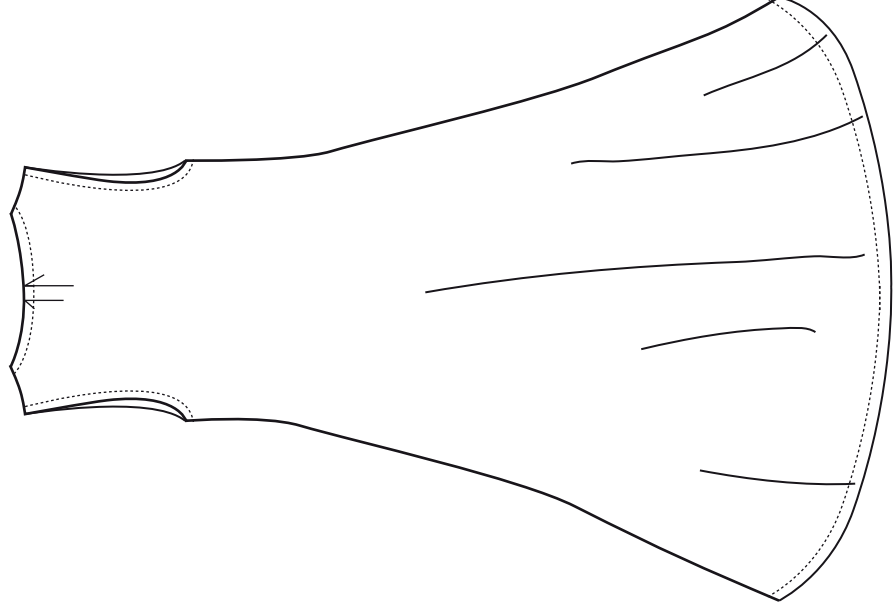
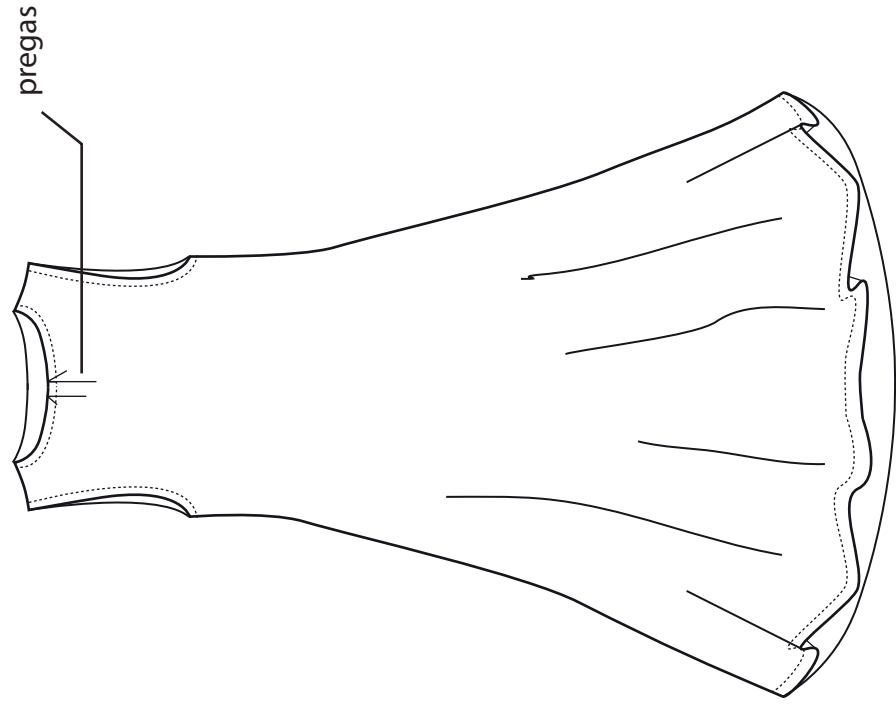

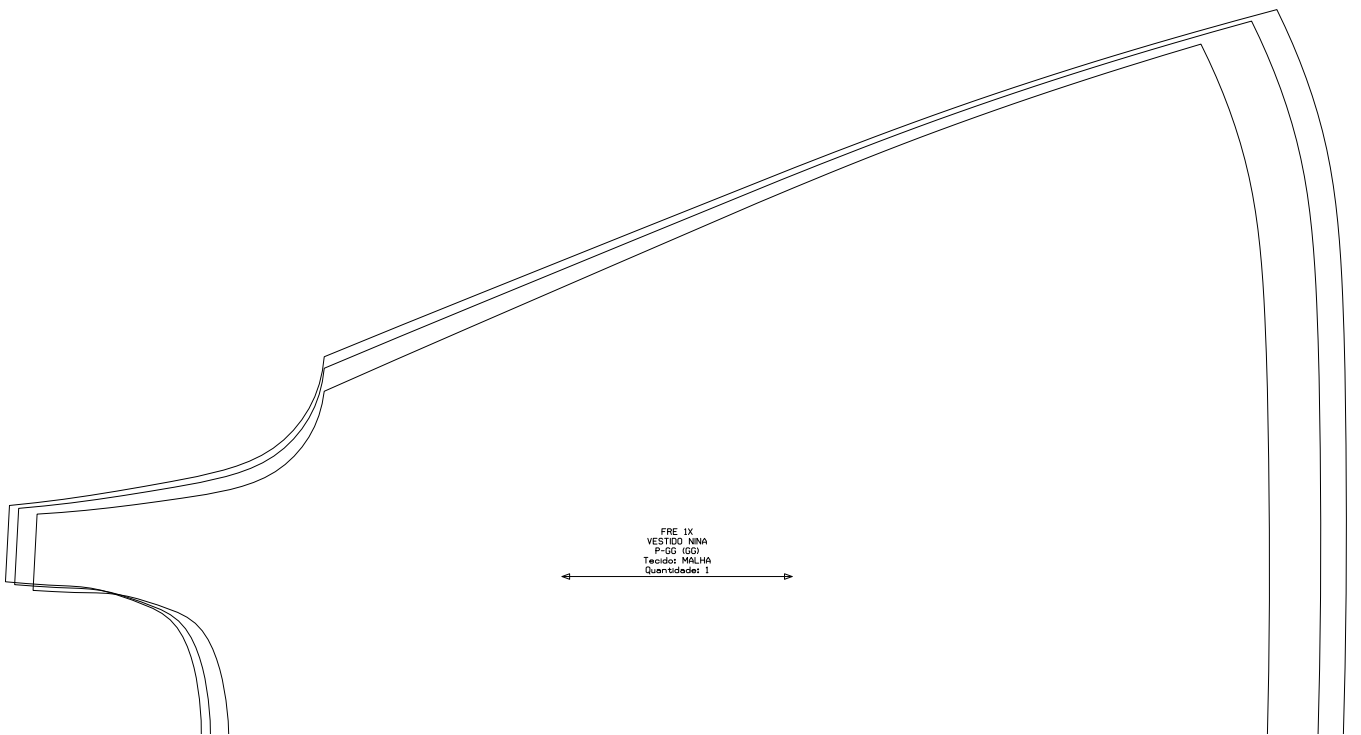
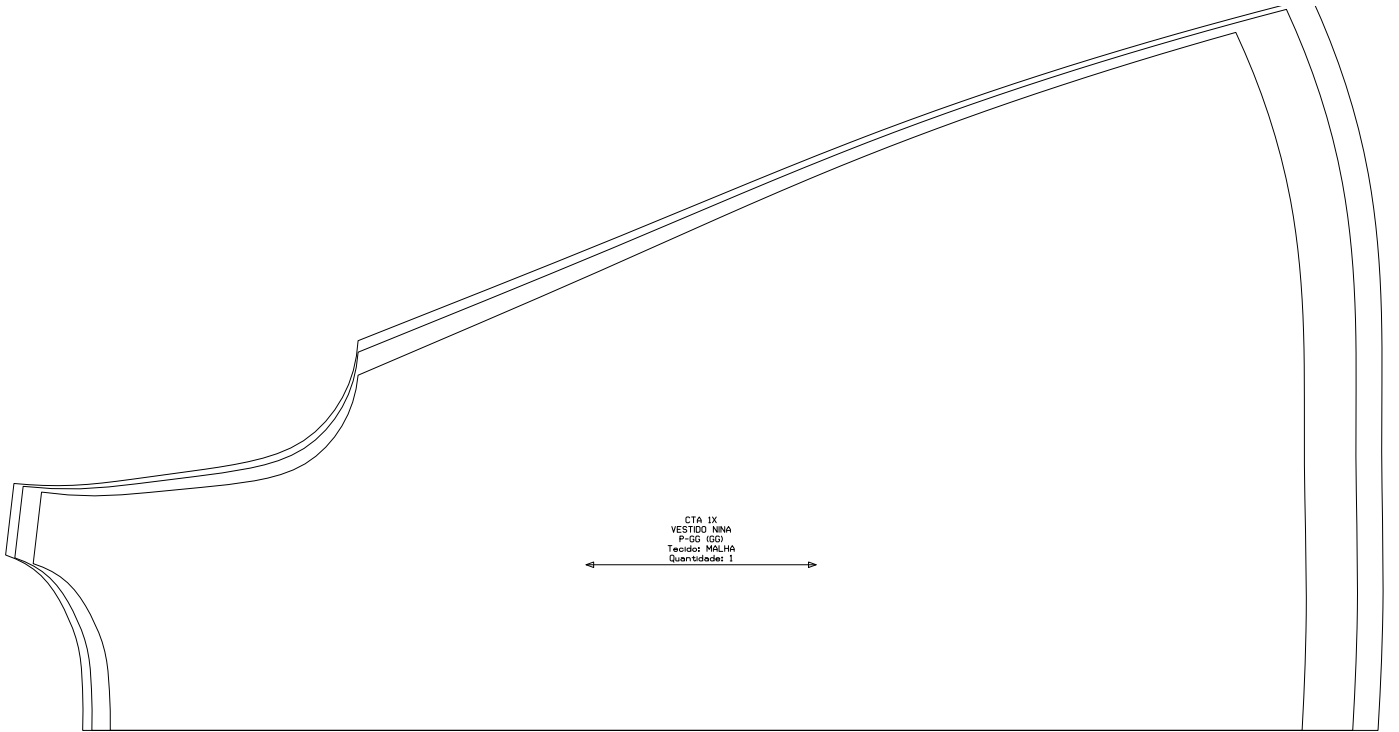

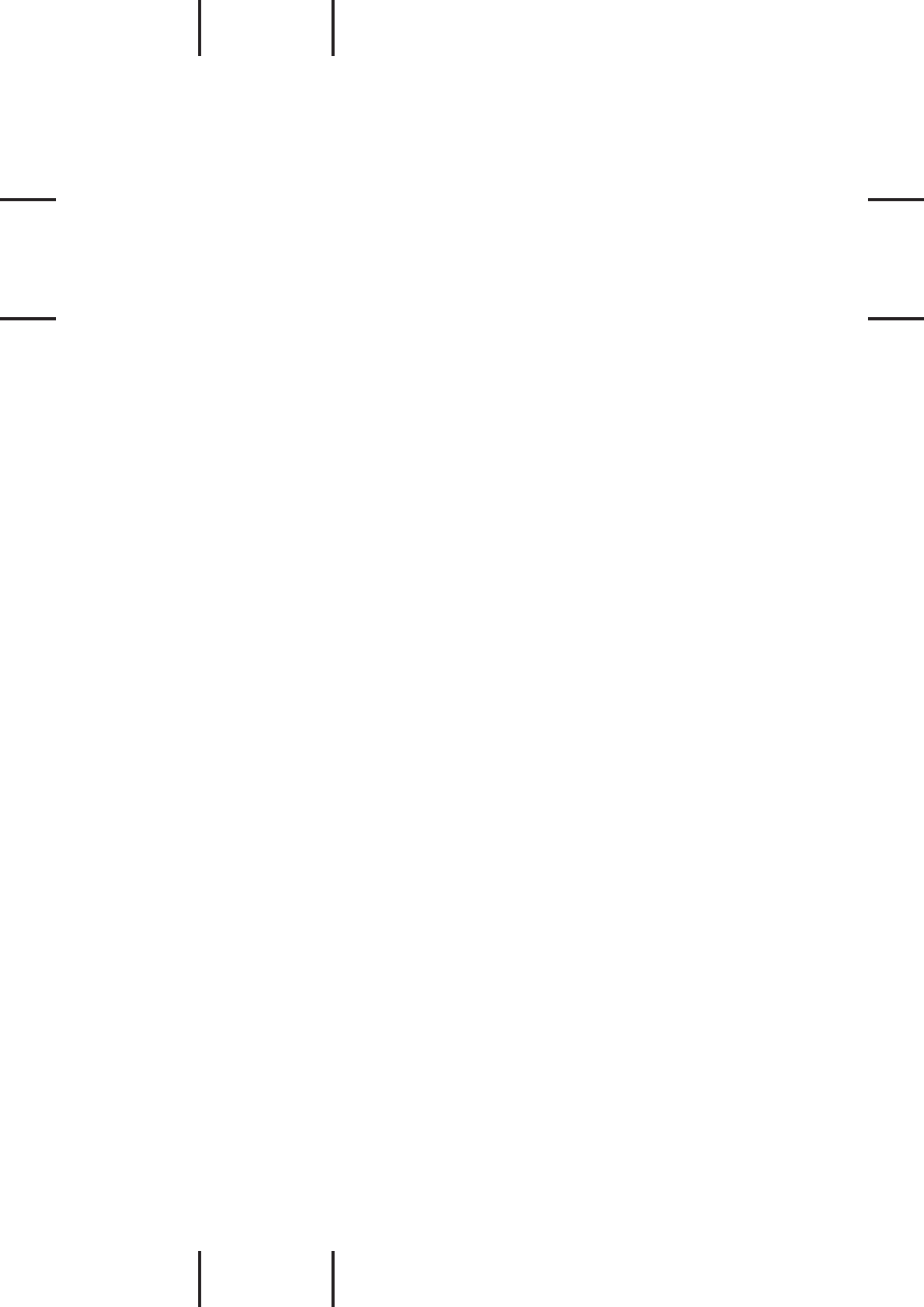

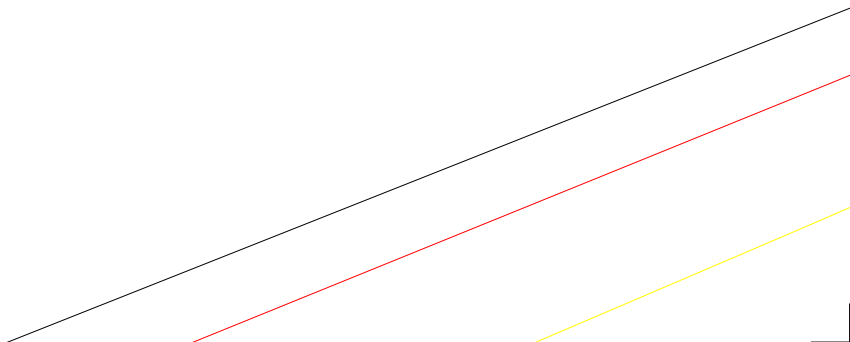

—

—

—

—

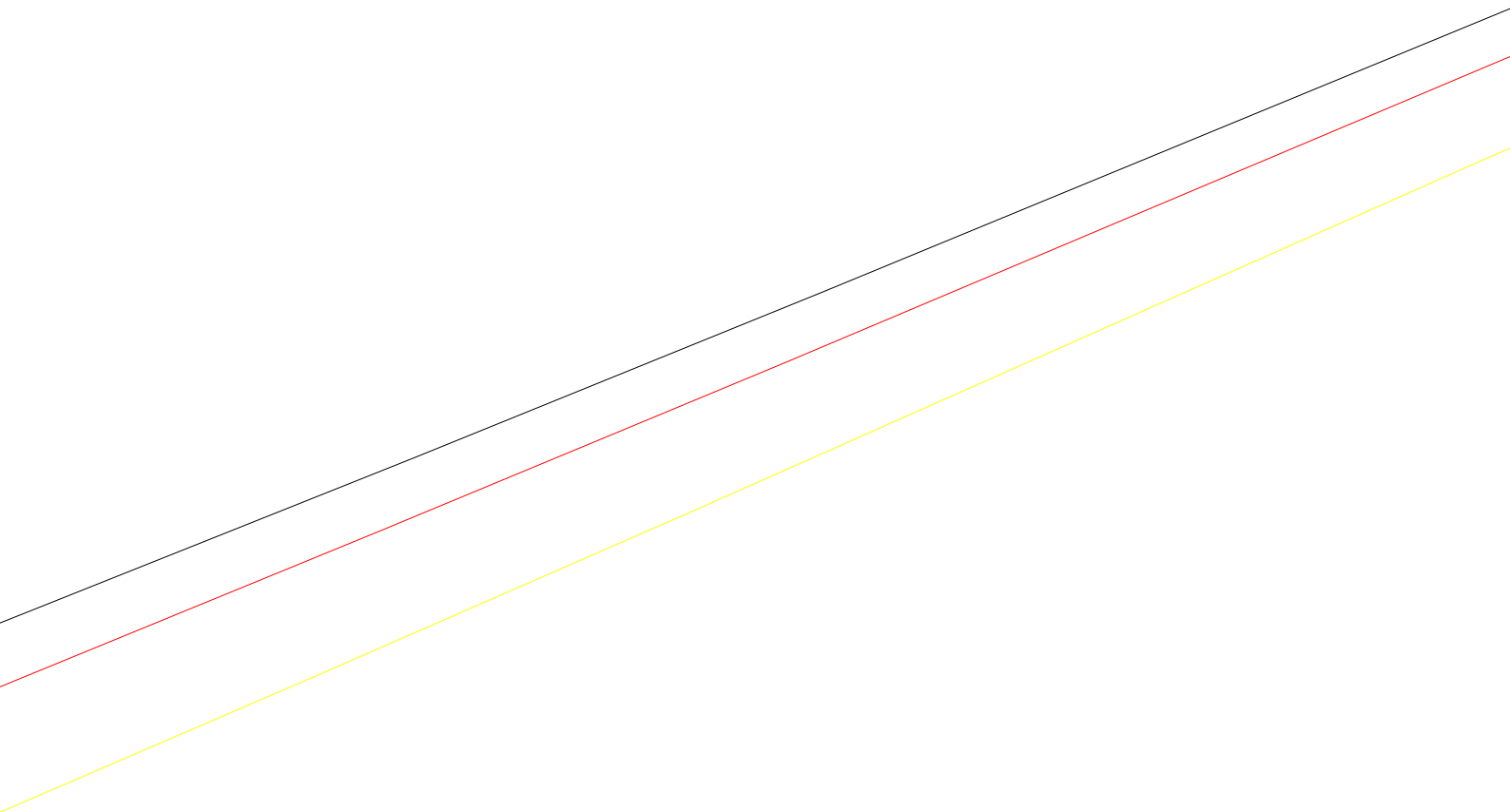

—

—

—

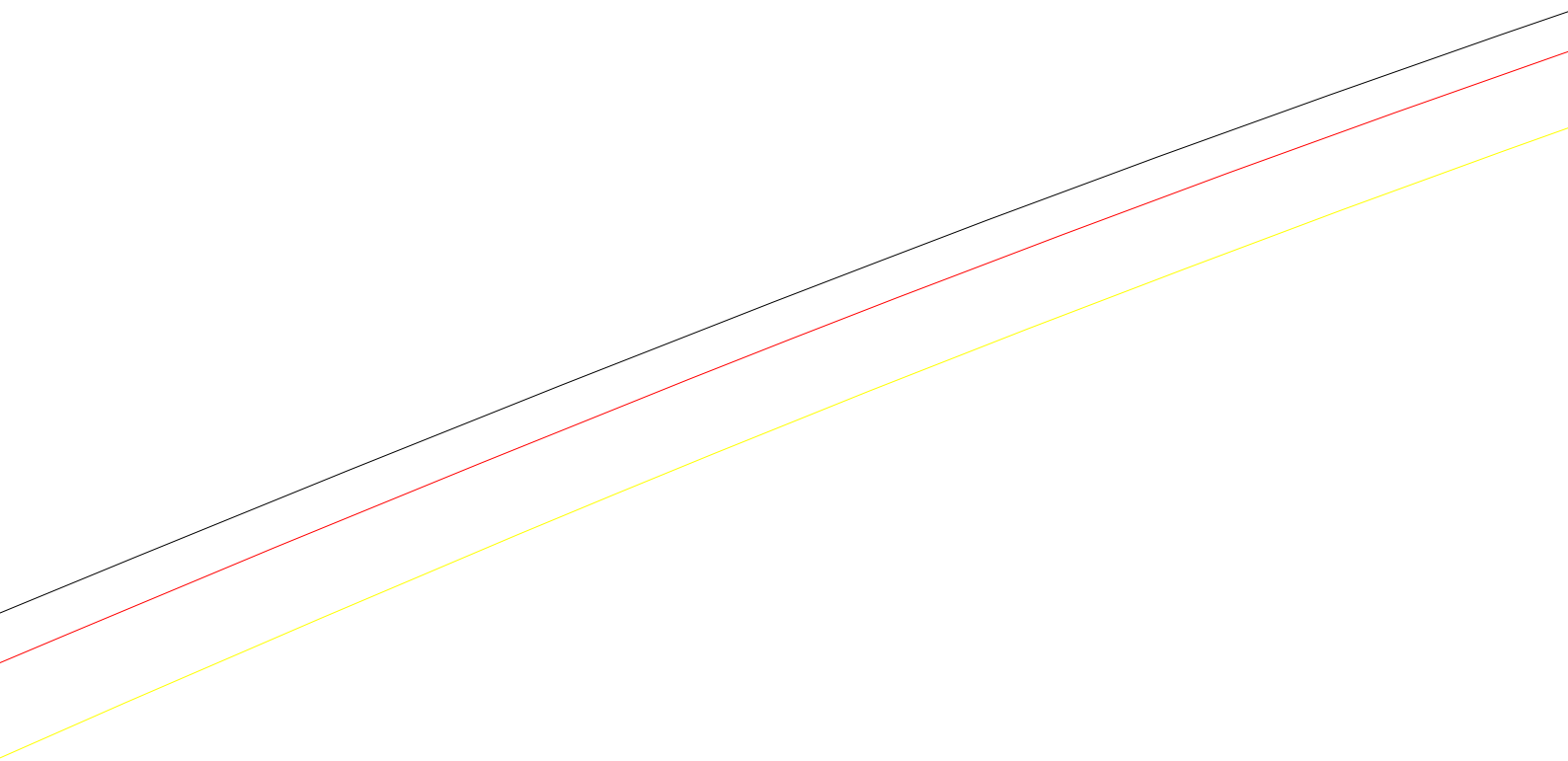

1,5

—

—

—

—

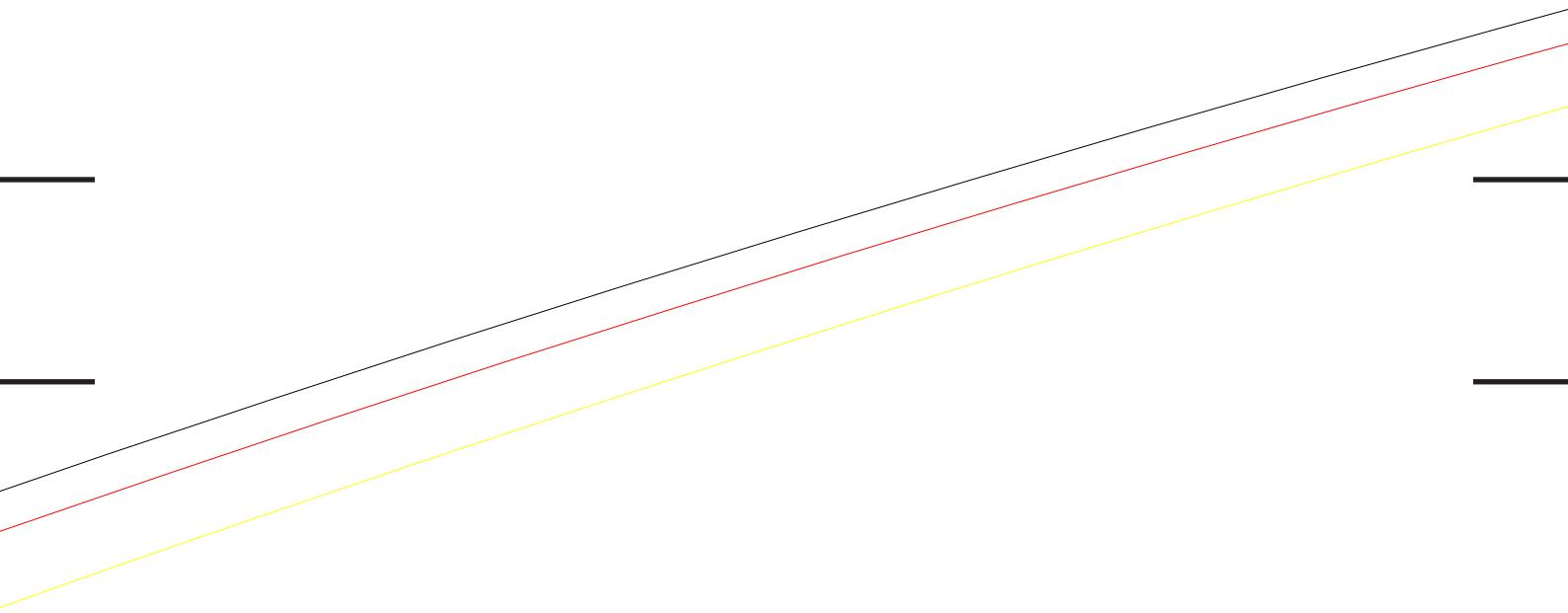

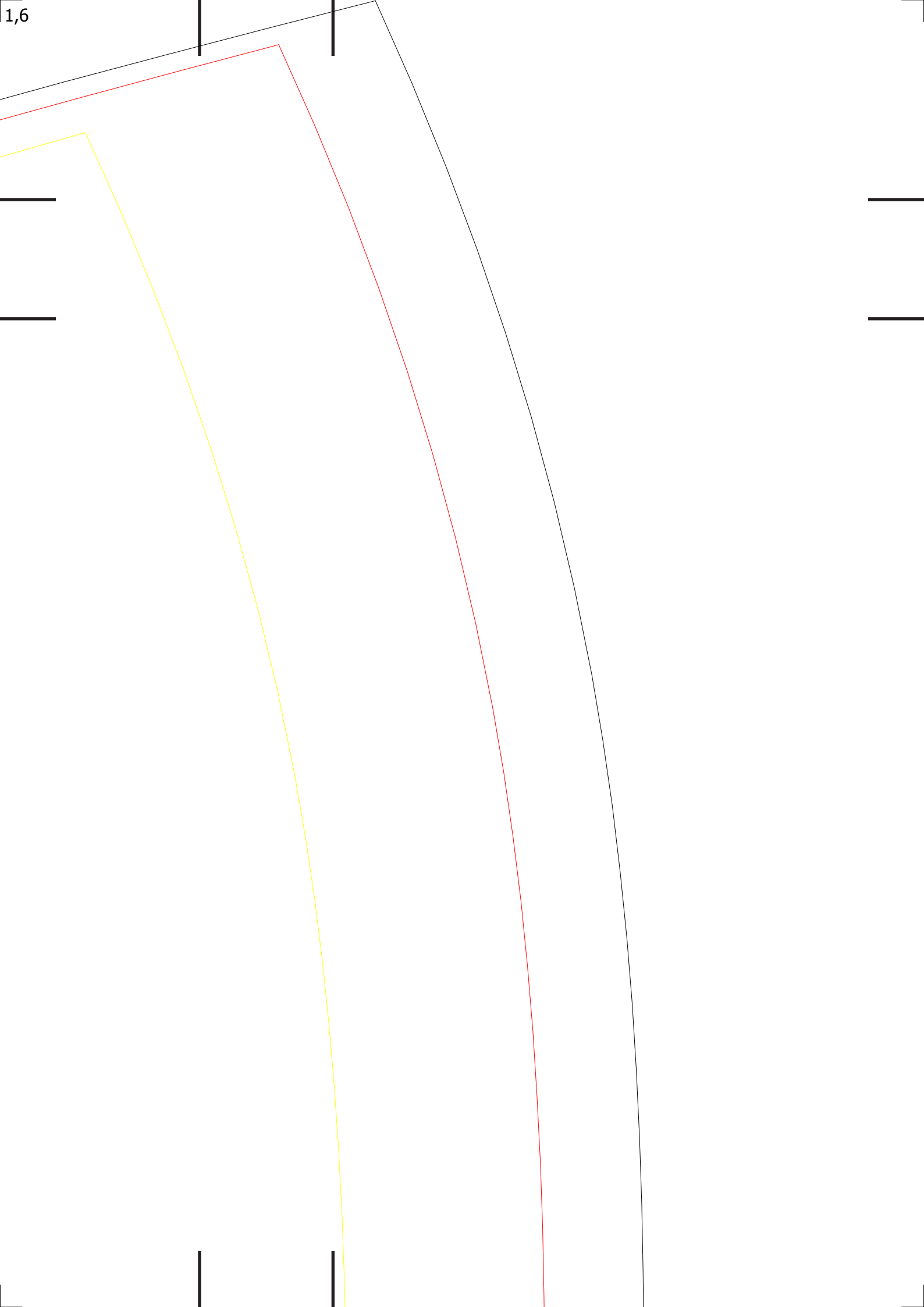

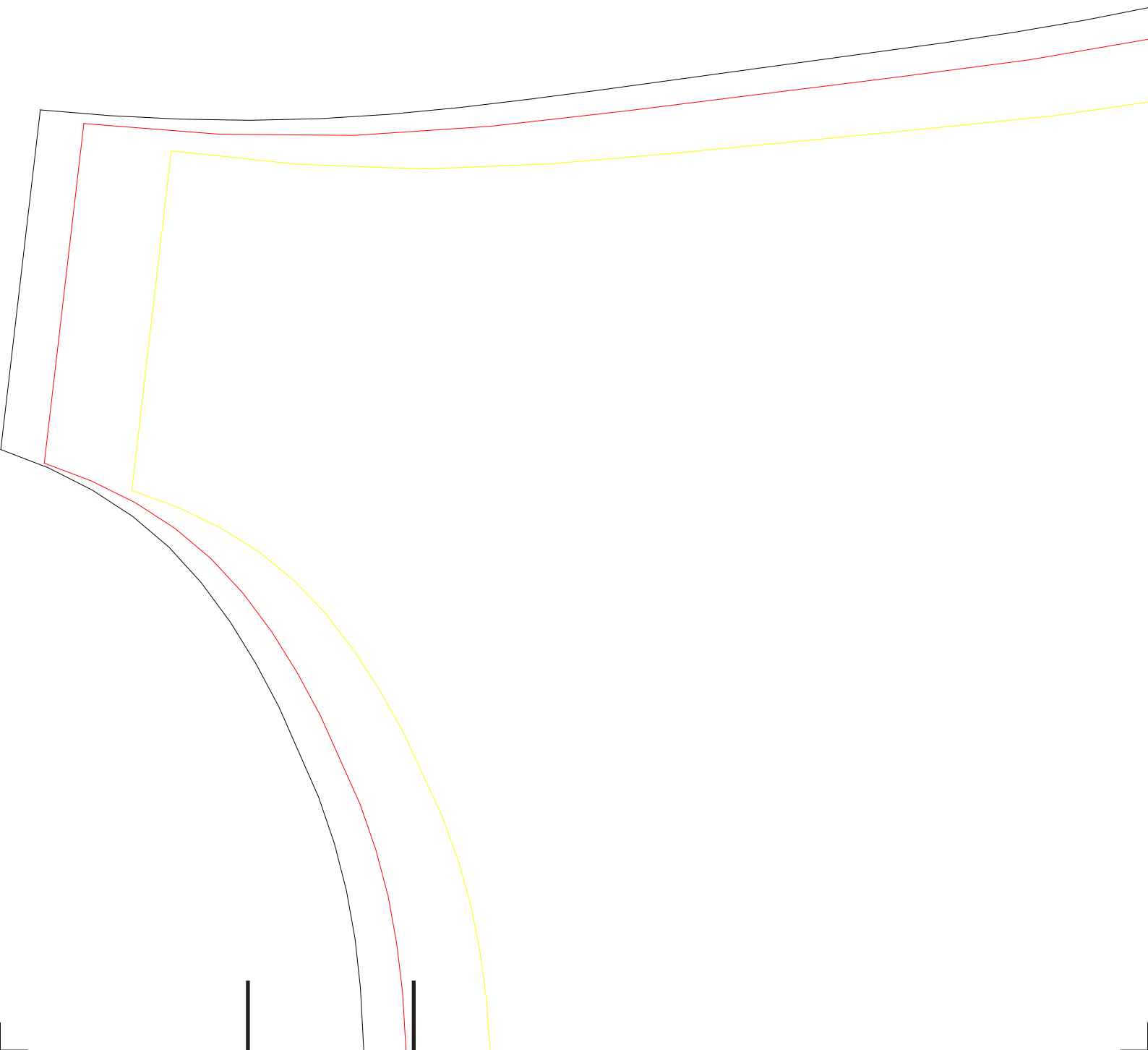

2,2

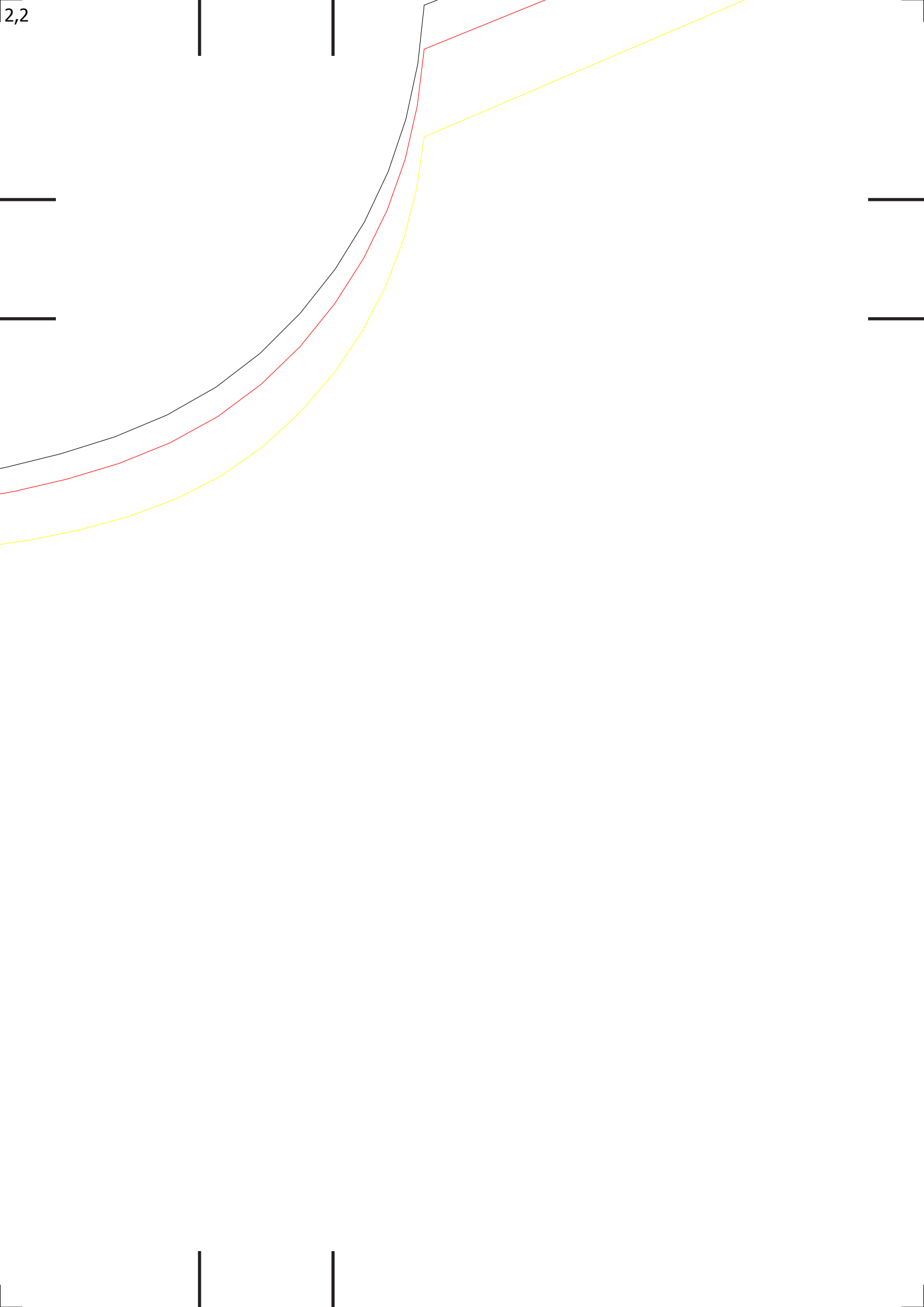

CTA 1X
VESTIDO NINA
P-GG (GG)
Tecido: MALHA
Quantidade: 1



1



1



|

|

|

|

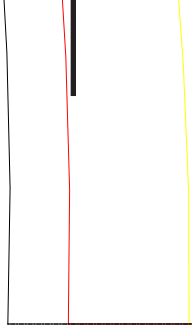





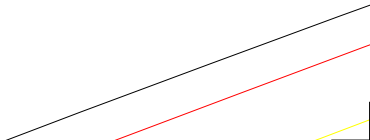

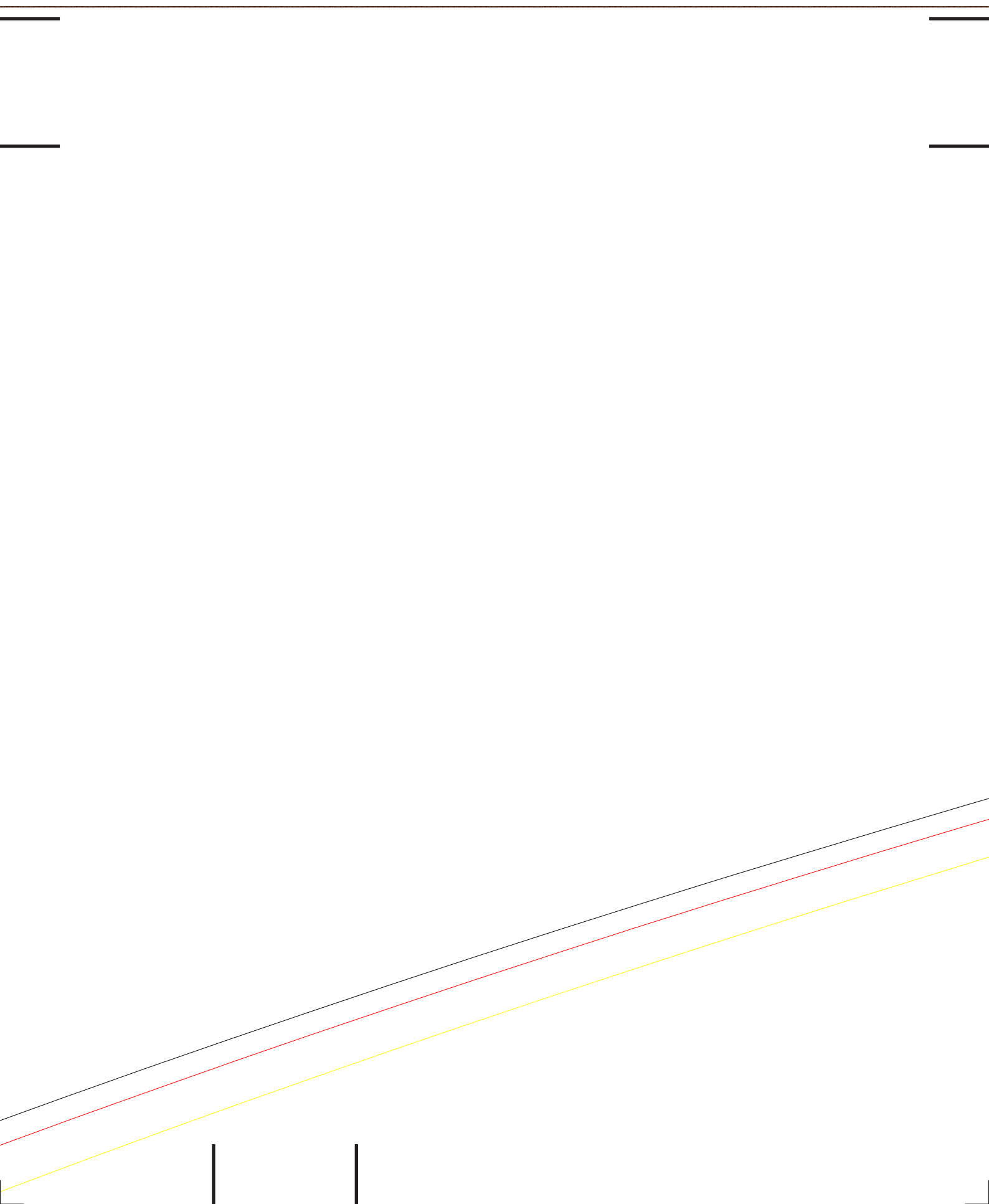

3,6

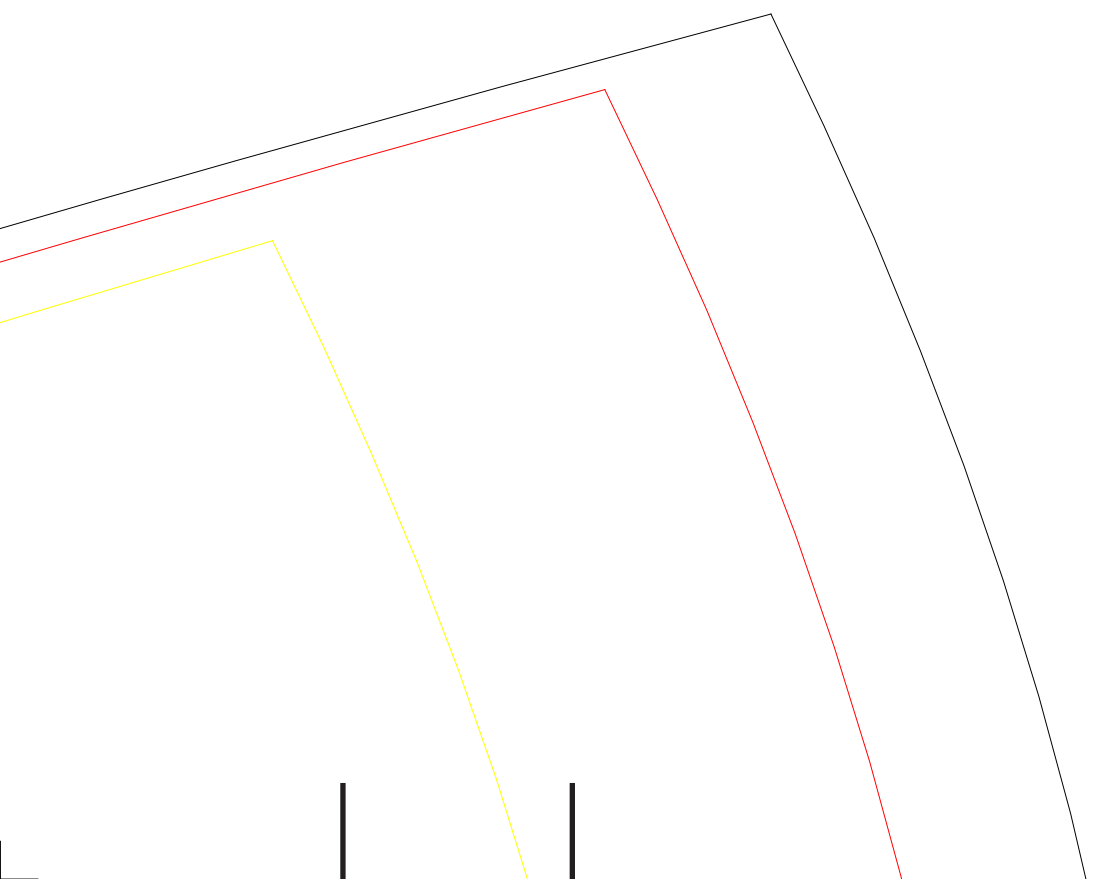
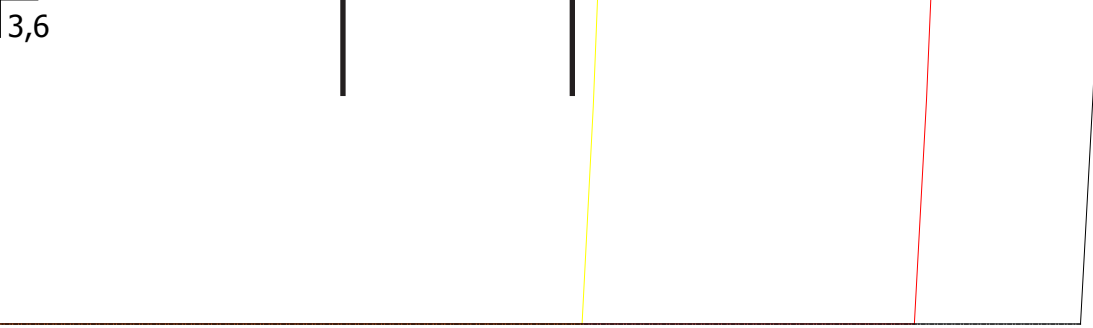



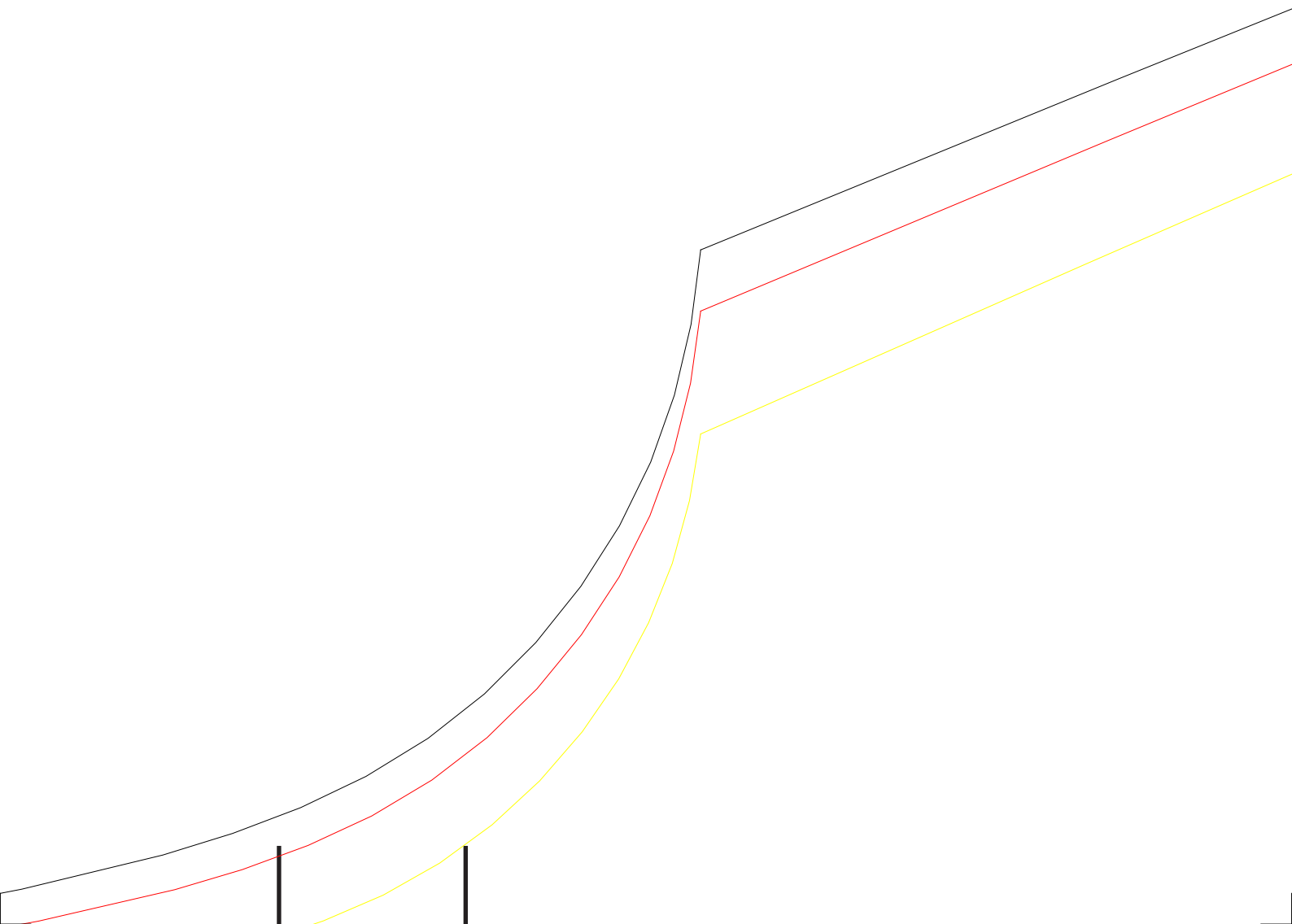

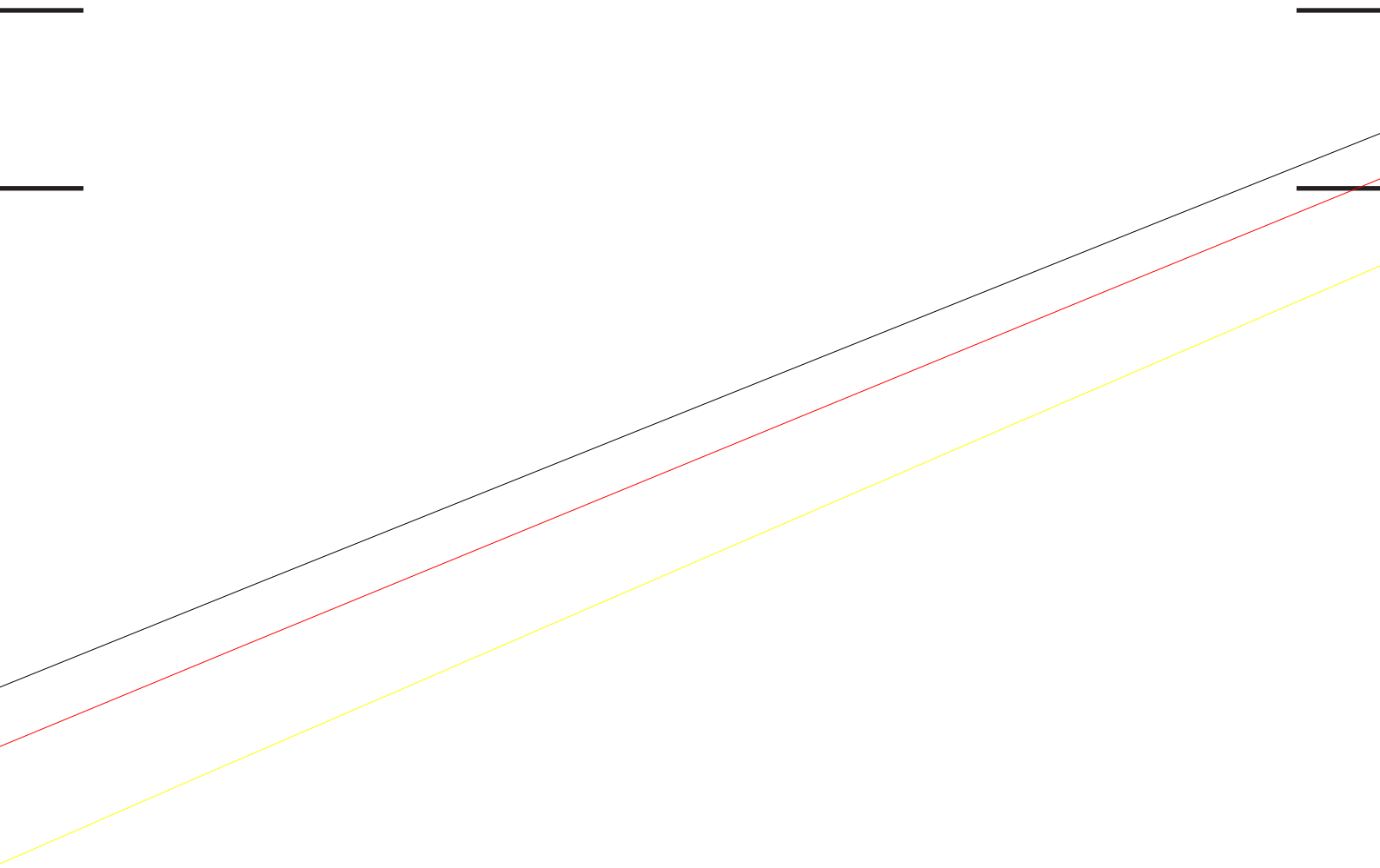

4,4

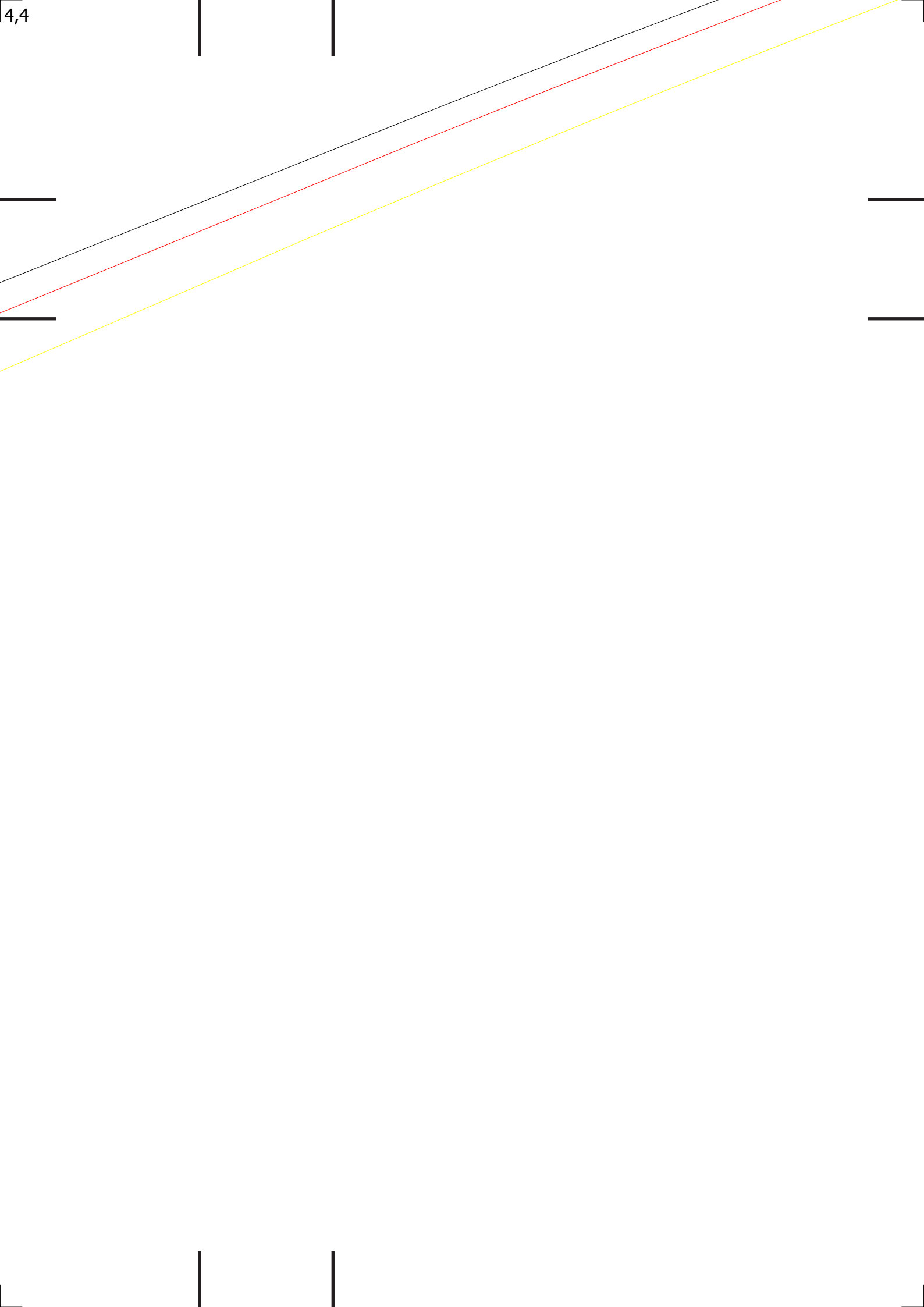

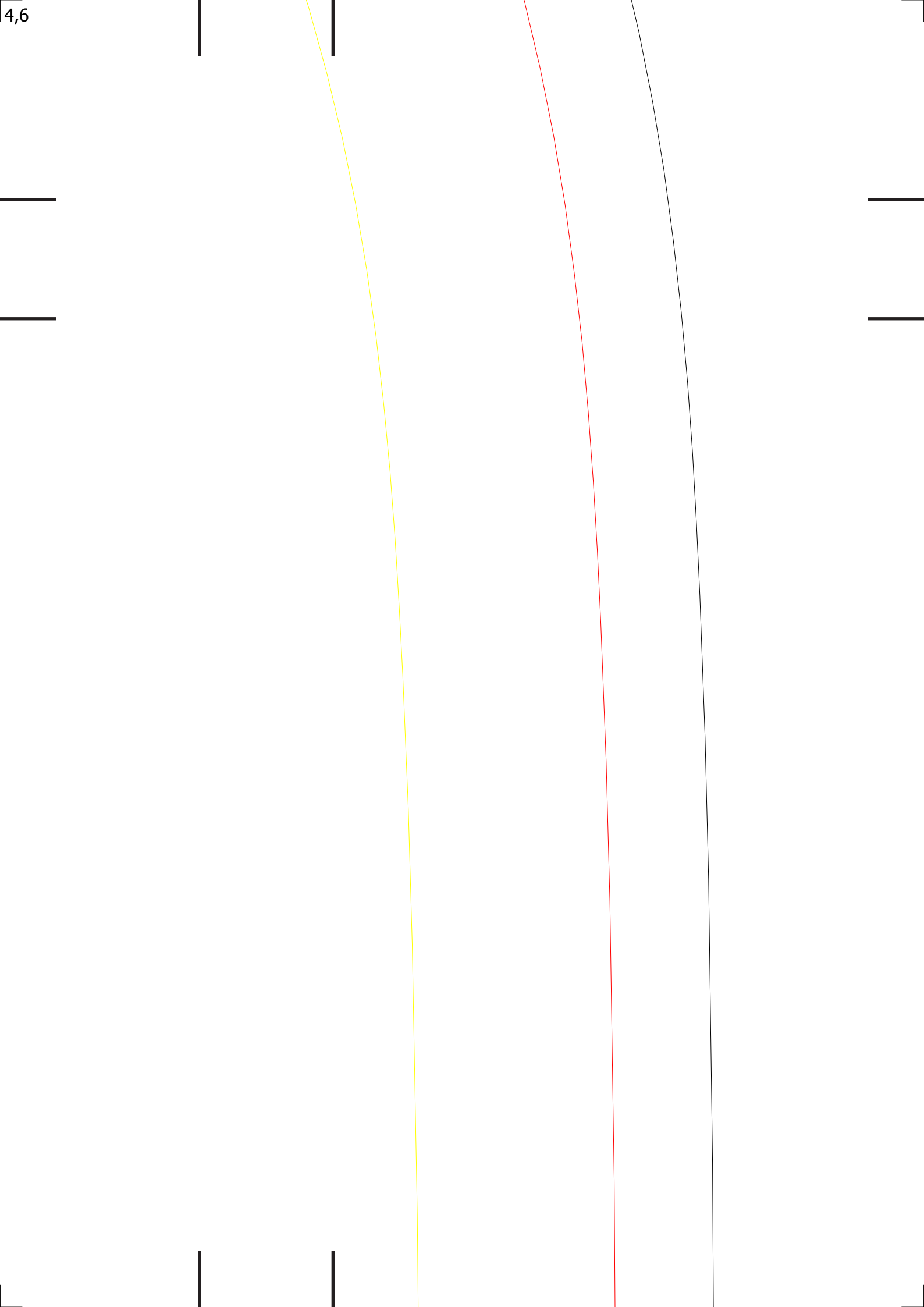

5,1

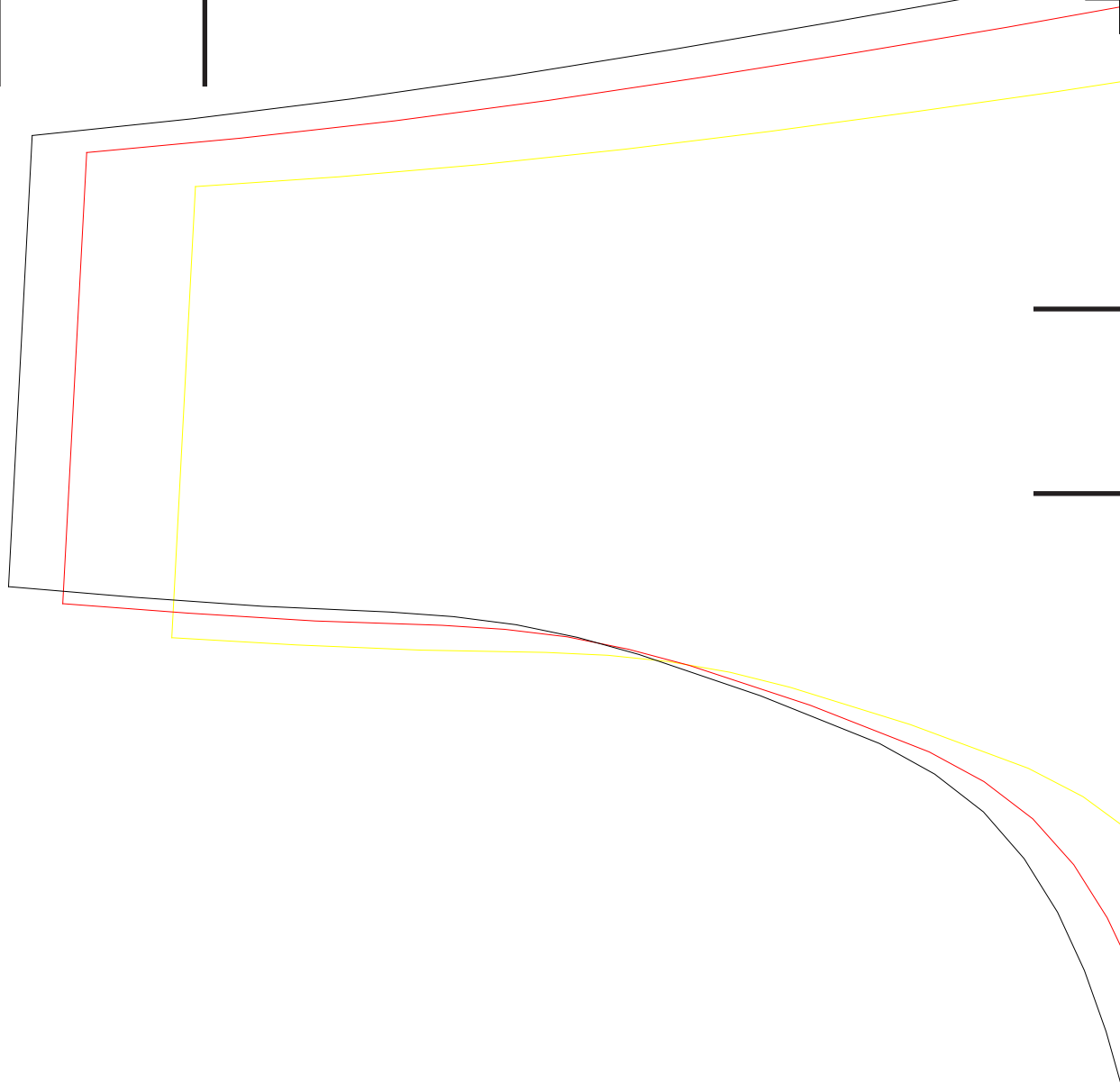

5,2

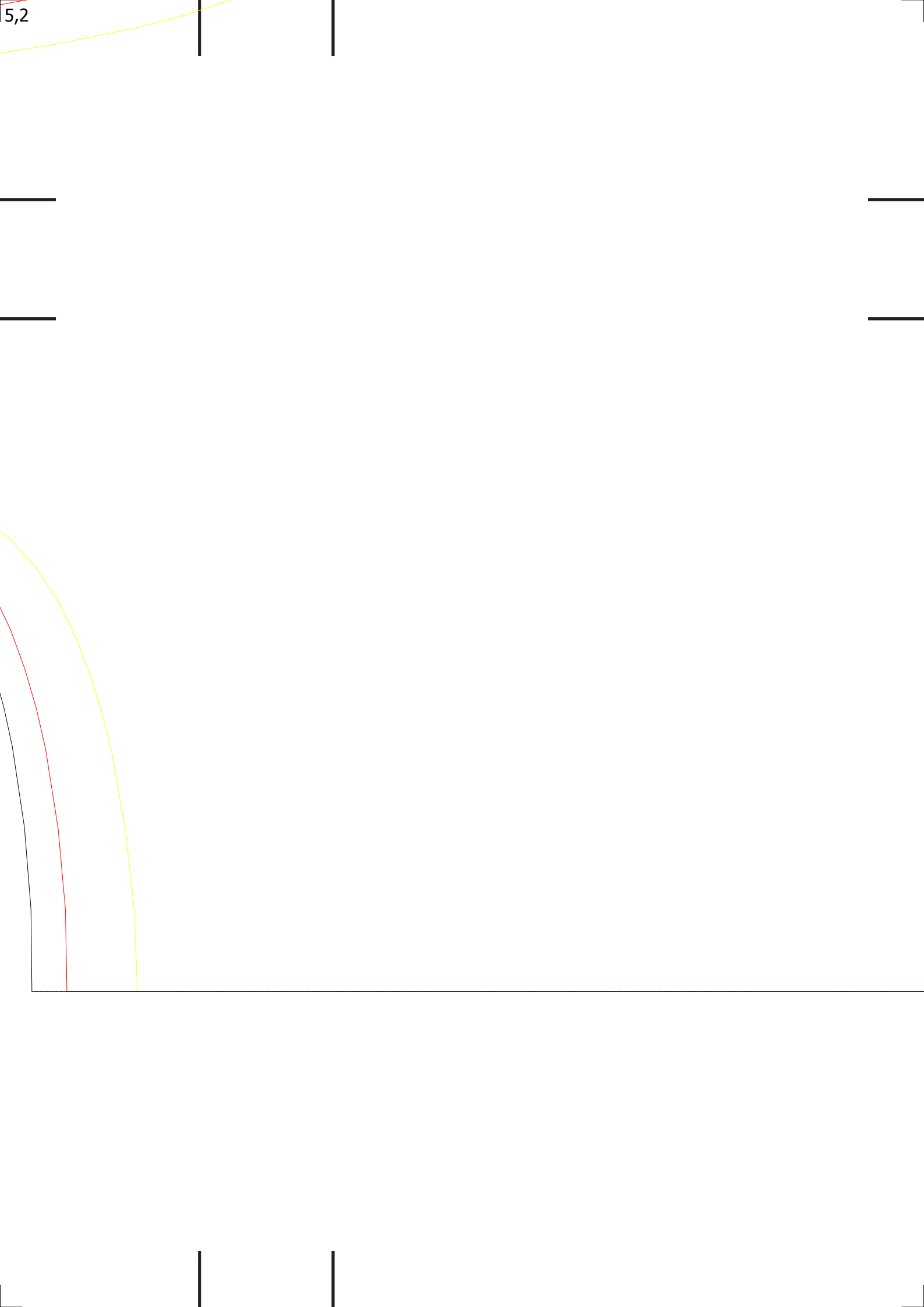

ERE
VESTID
P-GG
Tecido:
Quantia

1X
O NINA
(GG)
MALHA
idade: 1

